

LEADING EDGE INSTRUCTION LEAFLET
PLATFORMS, RACKS AND MINI-PANELS – ALL TYPES
SETUP, USE AND CARE

1. Handling and Safety

- Many of the Leading Edge products are heavy – take the utmost care when unpacking and installing the components and when installing equipment to avoid injury, knocks or dropping the items. If in doubt ask a second person to assist.
- You should read all instructions very carefully before commencing assembly – these procedures are very important to achieving correct operation and performance, and to avoid damage to the beautiful finish of the products.

2. Systematic Approach and Correct Choice of Products

- This leaflet just describes the detail physical setup of the Leading Edge products.
- The leaflet assumes you have received full support from your dealer about the philosophy and technical principles of the products, and specific Systematic Approach guidance for your system.
- You should have also received full guidance about the correct choice of products and their sizes. Your dealer should make sure you get the correct footprint requirements with products, particularly with requirements to house all your electronics, or for the correct size of loudspeaker platforms.
- Please contact your Leading Edge dealer if you are unsure about any of the instructions on this leaflet.

3. Coupler/Decoupler Positioning and Platform Leveling

- The Coupling Tripod is a critical part of acoustic performance of the whole platform and rack system.
- For correct performance the unit/player must be raised up off its own feet, and the Coupler positioned on one of the 2 stainless steel inserts.
- The Decouplers are designed to give some isolation, leaving the Coupling Tripod as a single drain path. The other purpose of the Decouplers is to give stable and secure support the player/amplifier and keep it level.

Through the hole in each corner of platform use 4mm Allen key and rotate stop-choc foot to raise/lower and level platform.

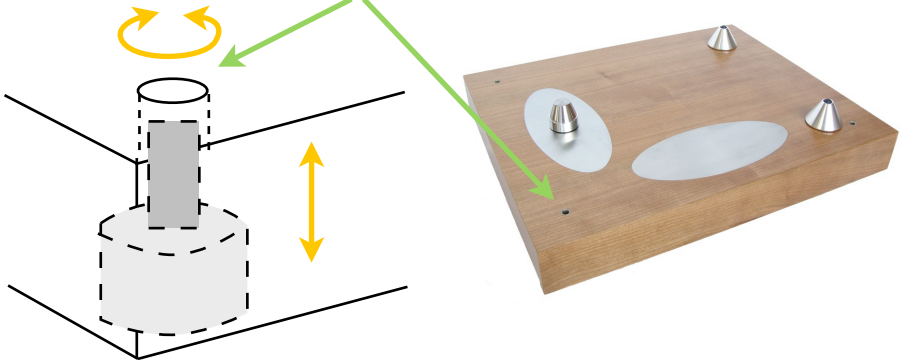

- It is also critical for performance that each platform is correctly supported on its stop-choc feet, and that no part of the platform body is in contact with any supporting structure. The platform should always be 'isolated and floating' on the stop-chocs. The stop-choc at each corner is height adjustable through the holes in the top of the platform.

4. Platform Setup on Third Party Racks or Shelves

- Before installation ensure there is adequate space and clearance for the platform, and its equipment, particularly vertical height, to allow proper adjustment.

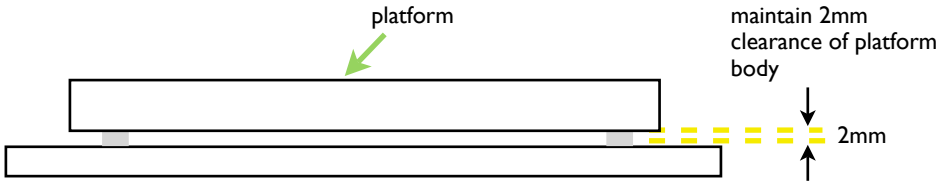

- Adjust the stop-choc feet for 2mm clearance of platform body above shelf. You may need to check and adjust again later once your component is installed.

5. Platform Setup on Leading Edge Racks

- Again it is critical for performance that platform bodies are not in contact with any part of the rack assembly. The rack design provides minimal clearance gaps to enhance the look of your Leading Edge rack system, but when correctly installed, only the stop-choc feet are in contact with the steel cross-frames of the rack.
- Carefully adjust each platform to achieve the position and clearances as shown below. You may need to check and adjust later once your components are installed.

Adjust stop-chocks to lift platform so that top surface is flush with rack frame. Fine adjust to level. Keep load even on all stop-chocs.

Keep clearance equal all round to ensure body of platform is not touching rack structure.

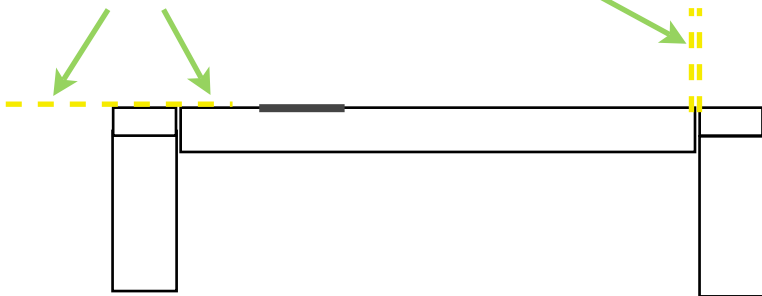

6. Equipment Setup with Coupling Tripod and Decouplers

- Check that the height of the player's/amplifier's feet is less than the height of the Coupling Tripod/ Decoupling Supports. If not, you will need to remove the player's feet.

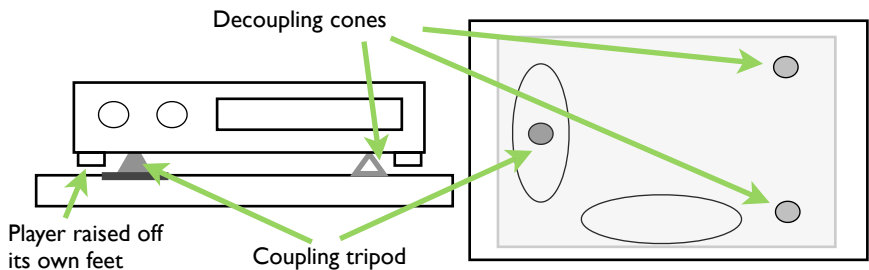

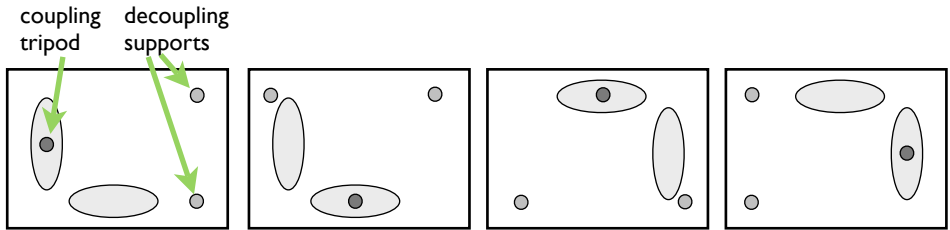

Stainless steel inserts front and left, or rotate the platform through 180 degrees for rear and right position - this gives four coupler/decoupler position options

- Determine where, under the player/amplifier you are going to position the Coupling Tripod - normally this should be under the heaviest end, or side, of the player, probably where the power supply within the unit is situated. Orientate platform for required coupler/decoupler configuration. Place the player/amplifier directly onto the Platform without using the Coupling Tripod or 2 Decoupling Supports at the moment, and reconnect.
- Gently lift the player/amplifier at the opposite side from the position where you are going to use the Coupling Tripod, and slide under the Decouplers. Position well apart for stability and away from screws and protrusions on the base plate. Note that for correct positioning, the Decouplers will be on the wooden surface of the platform, they are not required to be positioned on the stainless steel inserts.
- Finally, gently lift the player/amplifier on the other side, and carefully position the Coupler on the required stainless steel insert. Gently lower the player onto the Coupler. Do not bang the player down, or move the coupler once the weight is upon it. The coupler will function optimally just with the weight of the player upon it.

7. Assembly of Rack and Platform System

- Fit large stop-choc feet to underside of base rack.
- Locate base in exact floor location where stack is required (do not attempt to move completely assembled stack).

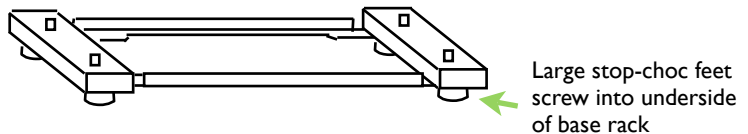

- Level base by adjusting feet and ensure load is even on all feet.
- Position first platform onto base frame.

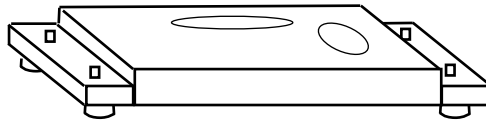

- Next, Place two separator pieces over the machine screw spigots on the base rack.

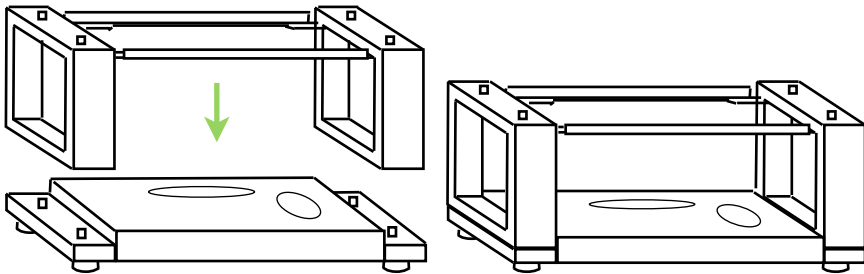
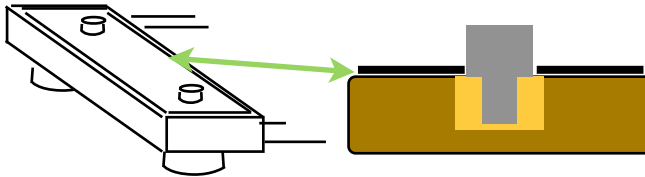

- Position first rack frame over the base frame and carefully lower ensuring location holes on underside of rack frame mate with machine screw spigots on the base rack.
- With gentle pressure ensure the rack sits squarely down over the spigots and onto the separator pieces.
- Continue by repeating this procedure until the complete stack is built. It is worth planning and determining the required orientation of each platform in the stack before you assemble.

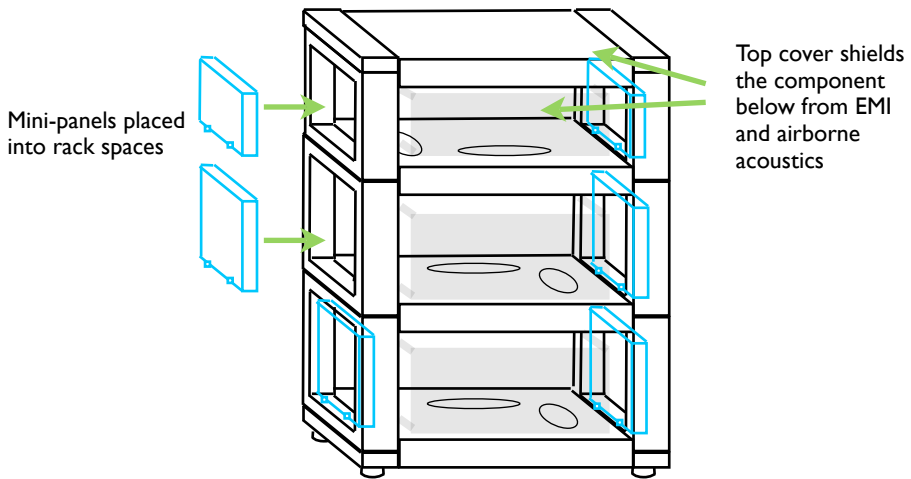

- The diagram above shows how the mini-panels are located within the space of the rack frames.
- Also shown on the top of the stack is the top cover. This is used to complete the EMI/ acoustic protection over the electronic component on the self below.
- On completion of build, check for the correct adjustment of all platforms. When electronics are installed and wired-up, check again. Detailed care and attention at all stages will ensure optimal performance.

8. Mini-Panels

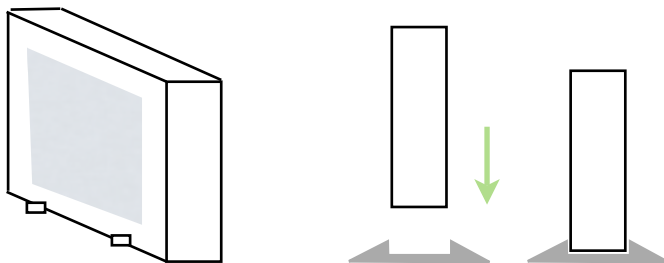

- Fit each mini-panel with two of the feet provided. The close fit of the panel into the foot is sufficient to support the panel – there are no screws or fastenings.
- The mini-panels should never be stood on the platforms, as this can feed extra unwanted vibration into the platform. When used with the racks, ensure mini-panels are only stood on the rack frame, not the platform.

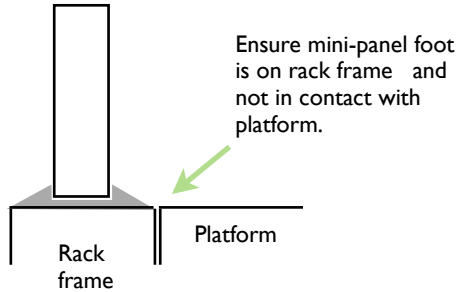

9. Floor-Standing Amp Platforms

- The floor-standing amp platform is optimized for large components that are too large to fit in the Leading Edge rack system. The platforms are square and have only a single stainless-steel insert. Orientate as required for best position of the stainless-steel insert.
- Adjust stop-chock feet to raise the platform body 2mm above floor surface. Ensure level, and even load on each stop-choc.
- Use Coupling Tripod and Decoupler set in the same way as for the other platforms.

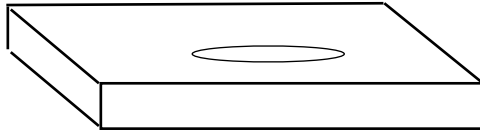

10. Floor-Standing Speaker Platforms.

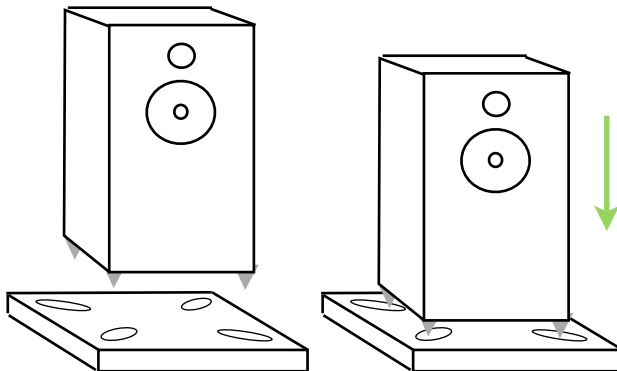

- Adjust stop-chock feet to raise the platform body 2mm above floor surface. Ensure level, and even load on each stop-choc.
- Carefully position speakers over the platform and lower into position taking care with position of spikes not to damage wood surface of the platform. This process should be carried out by two persons.
- If speakers are particularly heavy, you may need to remove the spikes, and place the speaker on the platform using some appropriate size wooden blocks under. Then replace the spikes and raise the speaker off the blocks with the spike adjustment.

11. Use and Care

- The adjustment of all stop-chocs should be checked periodically. Ensure that all platforms remain level and properly isolated on the stop-chocs. The stop-chocs may settle a little with weight, so they may require re-adjustment.
- Take care when installing or moving Coupling Tripod on platforms not to scratch surface of stainless steel plates or lacquered wood finish.
- Clean all surfaces with a soft cotton cloth. Do not wet. A small amount of good quality spray polish can be used but you should not apply polish to the stainless-steel plates - wax polish on the plates may reduce efficiency of acoustic transfer from the Decouplers.

12. Warranty

- All Leading Edge products have a 2-year parts and labour warranty which covers any failure of the product which has occurred during normal domestic use. Failure which may have occurred through misuse is not covered, examples include:
 - Damage caused by the use of inappropriate cleaning treatments.
 - Damaged caused by poor handling.

For enquiries, please contact either of the Leading Edge parent companies:

<p>Vertex AQ Limited Unit 6 Old Town Hall Workshops Temple Street Llandrindod Wells LD1 5DU Wales</p> <p>+44 (0)1597 825993 info@vertexaq.com www.vertexaq.com</p>	<p>Kaiser Acoustics GmbH Hanzing 1 Untergriesbach D-94107 Germany</p> <p>+49 8593 938 9112 info@hans-kaiser.com www.kaiser-acoustics.com</p>
---	--